

UK: 5220 / 5226

AU: 5220A / 5226A

Thermotouch Glass

Programmable thermostat for electric underfloor heating

Installation & User Guide

January 2018

thermotouch
UNDERFLOOR HEATING CONTROLS

Contents

Compatibility	3
What's in the box?	4
Before you start	5
Installing your thermostat	6
Wiring diagram	10
User interface	16
Set the time and date	17
Heating modes	18
Heating schedule	20
Settings	22
Technical data	24
Factory reset & key lock	26
Energy saving features	27

Compatibility

Thermotouch is compatible with Thermogroup NTC 10K floor sensor probes.

NTC 10k Ω @ 25°C

If you have an existing floor probe from another thermostat that is not compatible, set your thermostat to ambient temperature sensing mode.

(Not advisable for timber or other temperature sensitive floors).

Replacing an existing thermostat?

Contact the manufacturer's technical department and ask for the rating of the floor sensor at 25°C.

What's in the box?

Check you've got everything:

- Programmable thermostat
- Floor sensor probe (3m)
- Floor sensor conduit (2m)
- Fixing screws
- Installation guide
- Portrait mounting plate (AU only)

You will also need:

- Electrical screwdriver
- Deep electrical back box (UK only)
- Electrical test meter

Before you start

Your thermostat should be:

- Installed 1.2 - 1.5m from the floor
- On an internal wall
- Outside any wet zones (IP30)
- Installed on an RCD protected circuit
- Away from drafts or heat influences
- Installed so that the floor sensor probe can be laid in a heated area of the floor
- Installed by a professional, in line with current electrical regulations and relevant local standards

Installing your thermostat

1. Switch off mains power

You will be installing your thermostat as part of a high voltage mains electrical circuit. To ensure your safety and to protect the thermostat, switch off the mains power and remove fuse from the spur before you start the installation.

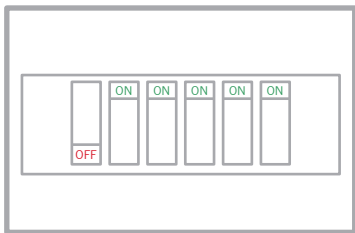
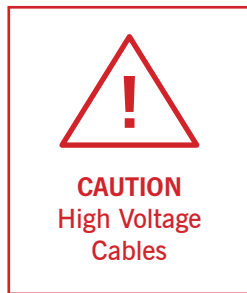

Fuse Box

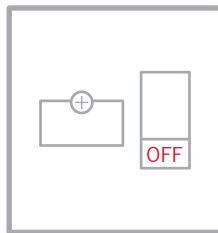

Fused Switch

Installing your thermostat

2. Installation location

At this stage it is likely that an RCD protected electric underfloor heating system has been installed and a back box is already in place.

The underfloor heating cold tail should be pulled up through the back box, and the sensor probe installed (in the conduit provided) within the wall cavity or pre chased channel in a solid wall.

Installing your thermostat

3. Maximum distances

Your thermostat can be installed up to 50m away from the underfloor heating system it is controlling, provided that the floor sensor is used to control the temperature.

Underfloor heating cold tails and floor sensor probes can be extended up to 50m.

Connect multiple heaters in parallel.



Installing your thermostat

4. Release mounting plate (UK)

Use a flat screwdriver to press in the catch (1) and push the black plate down (2) to release the clips holding the thermostat together. Separate the 2 sections (3) and disconnect the ribbon cable.

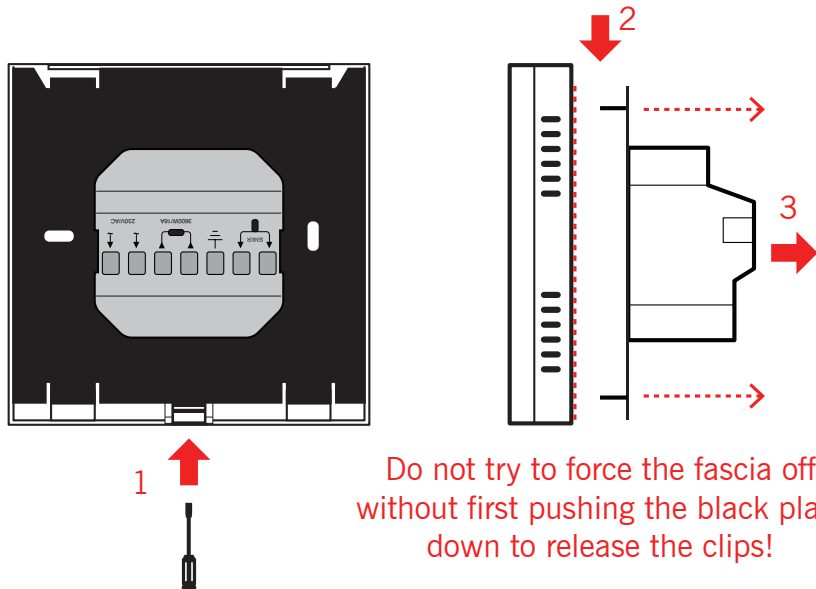

Do not try to force the fascia off without first pushing the black plate down to release the clips!

Installing your thermostat

5. Wiring diagram

Connect the Thermostat to the underfloor heating (UFH) cold tail, power supply and floor temperature sensor.

The floor temperature sensor is not polarity sensitive.

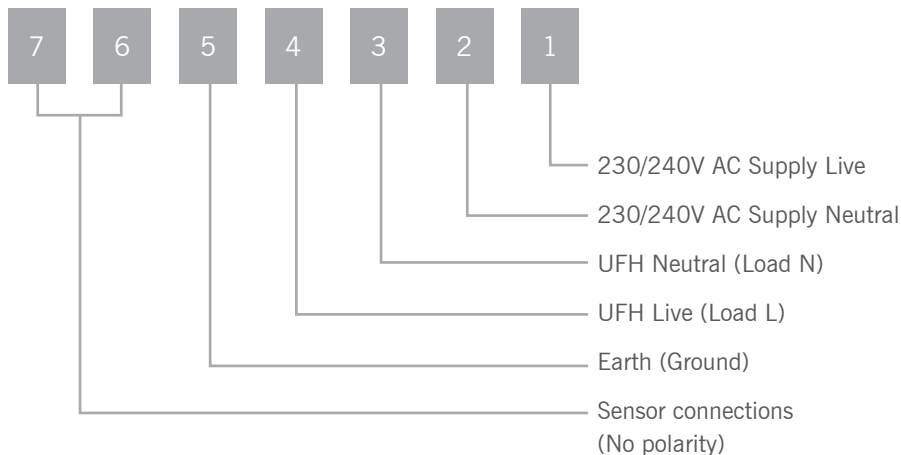

Installing your thermostat

6. Fix mounting plate in position (UK)

Use a screwdriver to fix the mounting plate to the back box in the wall. Now you can connect the white ribbon cable to the fascia.

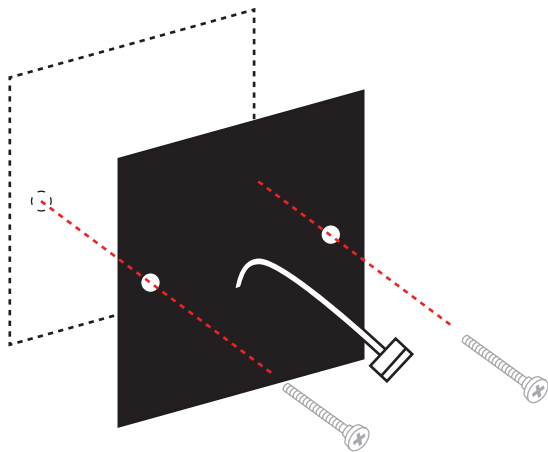

Installing your thermostat

7. Fix thermostat fascia in place (UK)

Locate the thermostat onto the mounting plate and push down to clip in place.

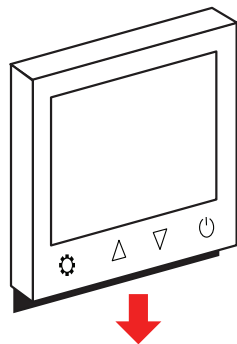
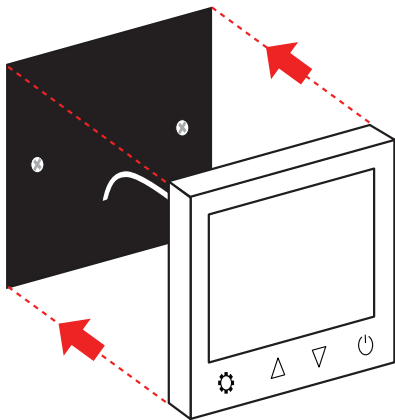

Installing your thermostat

8. Fix mounting plate (AU)

If you are installing the AU version the wiring diagram is the same, but the fixing plate works differently. Release the mounting plate from the case and use a screwdriver to fix the mounting plate to the wall. Pull UFH cold tail, mains and sensor cables through and connect cables as shown on p10.

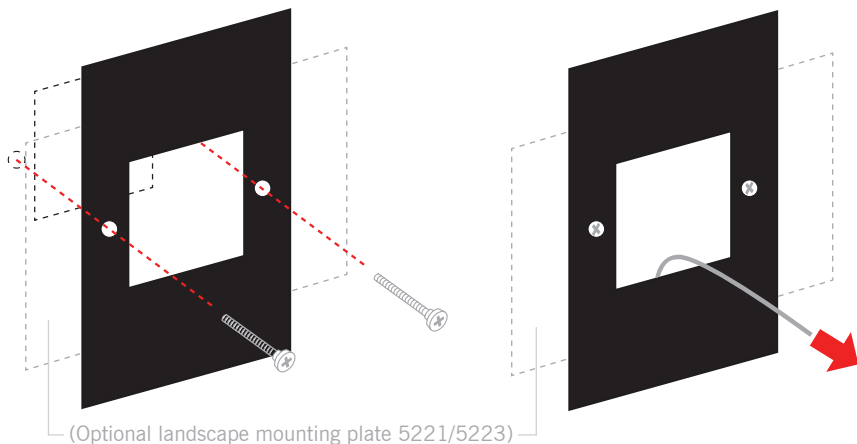

Installing your thermostat

9. Fix thermostat in place (AU)

Clip the plastic mounting plate over the steel plate and locate the thermostat onto the steel clips. Push down to secure the thermostat in place.

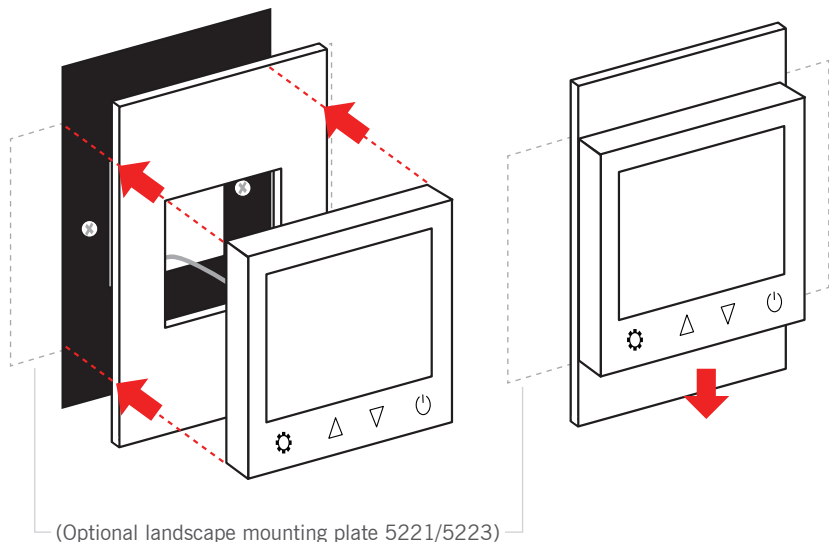

Installing your thermostat

10. Switching on your system

It is important that all adhesives and grouting is dry and fully cured before you switch on your underfloor heating.

Most adhesives take between 7 to 10 days to cure. Follow manufacturer guidelines.

The temperature of your underfloor heating should be increased gradually to avoid thermal shock in the floor. Start at 15°C and work up to your desired temperature 2-3°C per day.

Observe any maximum temperature guidelines from your floor manufacturer.



**Wait for
7 - 10 Days
before you
switch on**

User interface

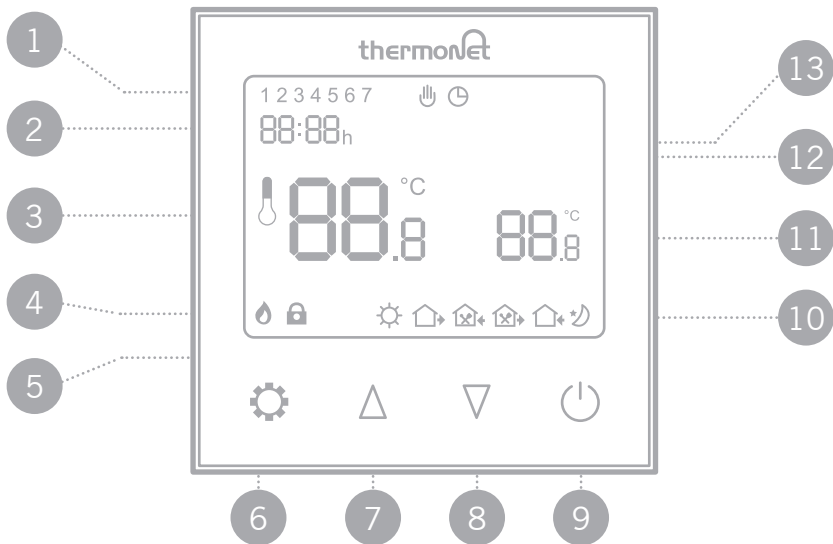

- | | | |
|-------------------------|-----------------|------------------------|
| 1. Day indicators | 6. Mode button | 11. Set temperature |
| 2. Time | 7. Up arrow | 12. Manual mode icon |
| 3. Measured temperature | 8. Down arrow | 13. Schedule mode icon |
| 4. Heating on icon | 9. Power button | |
| 5. Lock icon | 10. Event icons | |



Setting the date and time



Setting the day and time

Switch the unit off by pressing .

Press and hold  for 7 seconds until the time begins to flash.

Use  and  to select the correct minute.

Press  to switch to hours and use  and  to select the correct hour.

Press  again to edit the day and use  and  to select the correct day. 1 = Monday & 7 = Sunday.

Press  to save your settings.

NOTE: The thermostat will switch off after 30 seconds of inactivity and any unsaved settings may be lost

Heating modes

When your thermostat is on you can tap  to switch between Manual and Schedule heating modes.

Manual mode

Your thermostat will simply maintain the temperature you set manually until you ask it to do something else!

Schedule mode

Your thermostat will follow a heating schedule that you can set by following the instructions on page 20.

Manual override

If you change the set temperature while the thermostat is running the heating schedule, the new selected temperature will be maintained until the next scheduled temperature change. The thermostat will then revert to the preset heating schedule.

Heating modes

Heating schedule settings

In the advanced settings (see page 23) you can choose between 3 different heating schedules.

1234567 (Flashing) 7 individual days. Every day can be programmed to follow an individual heating schedule.

1234567 Monday to Sunday the same. Every day will follow the same heating schedule (6 heating events per day).







123456 Monday to Saturday the same and Sunday separate (6 heating events per day).







12345 Monday to Friday the same with Saturday and Sunday separate (6 heating events per day).







What is a heating event?





A heating event is an opportunity to change the temperature in your heating schedule. Most people use 3 on and 3 off.

Set up your heating schedule



1. Turn the thermostat on by pressing .
1. Press  to switch to  mode before you start.
2. Press  to switch the unit off.
3. Press and hold  for 7 seconds to edit your schedule. If you have already set the clock press  x3 to skip it.







4. Use  and  to adjust the start time for event 1 and press  to save. Now use  and  to select the desired Comfort (or "On") temperature between 20 - 28°C depending on your floor finish*. 
Event 1
Wake Up







5. Press  to advance to event 2 and use  and  to select the desired time to switch to a lower temperature. 
Event 2
Out
6. Press  to save. Now use  and  to select the desired Eco (or "Off") temperature between 16 - 20°C.







7. Press  to advance to event 3 and use  and  to select the desired time to switch to a higher temperature. 
Event 3
Home

Set up your heating schedule

8. Press  to save. Now use  and  to select the desired Comfort (or “On”) temperature between 20 - 28°C.

9. Press  to advance to event 4 and use  and  to select the desired time to switch to a lower temperature.
10. Press  to save. Now use  and  to select the desired Eco (or “Off”) temperature between 16 - 20°C.

11. Press  to advance to event 5 and use  and  to select the desired time to switch to a higher temperature.
12. Press  to save. Now use  and  to select the desired Comfort (or “On”) temperature between 20 - 28°C.

13. Press  to advance to event 6 and use  and  to select the desired time to switch to a lower temperature.
14. Press  to save. Now use  and  to select the desired Eco (or “Off”) temperature between 16 - 20°C.

15. Press  to activate your schedule and you’re done!



Event 4
Out



Event 5
Home



Event 6
Sleep

TIP! If you don't want to use all of the available heating events you can skip one by setting the same temperature as the previous event.

Advanced settings

Adjusting the settings

To access the settings, switch the unit off by pressing .

Press and hold  and  together for 7 seconds.

Press  to cycle between settings 01 to 18.

Use  and  to adjust the settings.

Switch the unit on by pressing  to save your settings.

NOTE: The thermostat will switch off after 30 seconds of inactivity and any unsaved settings may be lost

Advanced settings

MENU	DESCRIPTION	RANGE	DEFAULT
01	Temperature calibration	-8°C ~ 8°C	0°C
02	Maximum set point	5°C ~ 80°C	35°C
03	Minimum set point	5°C ~ 80°C	5°C
04	Sensor mode	IN (Ambient), OUT (Floor), ALL (Ambient with floor limit)	OUT
05	Frost protection	5°C ~ 15°C or Off	5°C
06	Floor temperature display	(ALL sensor mode only)	
07	Temperature limit	10°C ~ 80°C (For ALL mode only)	35°C
08	Heating schedule setting	1234567 Flashing (7 days separate) 1234567 (7 days the same) 123456 (6 days the same + 1) 12345 (5 days the same + 2) No numbers - Program off	7 days separate
09	Status after power failure	LA: On as before, OF: Off	LA

Advanced settings continued

MENU	DESCRIPTION	RANGE	DEFAULT
10	Factory reset	Re (yes)	
11	Backlight timer	10secs - 300secs (5mins)	20s
12	Backlight brightness level	1 (min), 2, 3, 4 (max)	4
13	Adaptive Start	1 (On), 0 (Off)	Off
14	Open Window Detection	1 (On), 0 (Off)	Off
15	OWD Off Time	2 - 30 minutes	15 mins
16	OWD Temperature Drop Limit	2, 3 or 4°C	2°C
17	OWD Heating on again after	10 - 60 minutes	30 mins
18	Software version	5220: 5100, 5220A: 7020 5226: 7024, 5226A: 7025	



NOTE: The thermostat will switch off after 30 seconds of inactivity and any unsaved settings may be lost

Technical data



Supply voltage	230V/240V 50/60Hz
Maximum load	16A
Backup storage	EEPROM (approx. 1 year backup)
Temperature range	5 ~ 80°C (0.5°C increments)
Accuracy	±0.5°C
Sensor rating	NTC 10kΩ @ 25°C
Consumption	2W
Warranty	3 years
IP rating	IP30
Width	85mm
Height	85mm
Depth	46mm (31mm in wall)

Factory reset & key lock

Locking the keys



To lock the keys press and hold  and  together for 7 seconds.

The  icon will appear when the keys are locked and the keys will not function.

To unlock the keys press and hold  and  together for 7 seconds.

Factory reset

Find menu item 10 in the advanced settings (page 24).

Press  and then . The thermostat will reset to factory settings after 7 seconds. This will totally erase the time, date, heating program and any adjusted settings.

Energy saving features

Adaptive Start

With the Adaptive Start feature enabled, Thermotouch will measure how long it takes for your individual floor to heat up and ensure the target temperature is achieved at the set time.

So if you set your heating schedule to 24°C at 07:00, the floor will be at 24°C at 07:00. No need to set the heating to come on early!

Thermotouch starts learning from the first time you enable the heating schedule. It turns on an hour early to start with and gradually optimises the heat up time over 7 days.

Open Window Detector

When the Open Window Detection feature is enabled, Thermotouch can detect sudden drops in temperature and will switch off your heating to eliminate wasted energy.

Thermotouch will come back on after 30 minutes, provided the temperature has stabilised.

You can activate and adjust these features in the advanced settings menu. See page 24.

Service and support

Thermogroup UK

Bridge House
Hop Pocket Lane
Paddock Wood
Kent TN12 6DQ
UNITED KINGDOM

0800 019 5899

01622 689 440

www.thermogroupuk.com
sales@thermogroupuk.com

Thermogroup EU

Pinnacle House
Newtown Cross
The Ward. Dublin 11
D11 K27C
Rep. of IRELAND

01 866 0584

www.thermogroupeu.com
sales@thermogroupeu.com

Thermogroup AU

Thermogroup Pty Ltd
PO Box 822
Leeton NSW 2705
AUSTRALIA

1300 368 631

www.thermogroup.com.au
sales@thermogroup.com.au



Watch the video guide on our website

www.thermogroupuk.com

www.thermogroup.com.au

Thermogroup



That little bit extra...