

Our recommended mesh solution for tile and stone floors

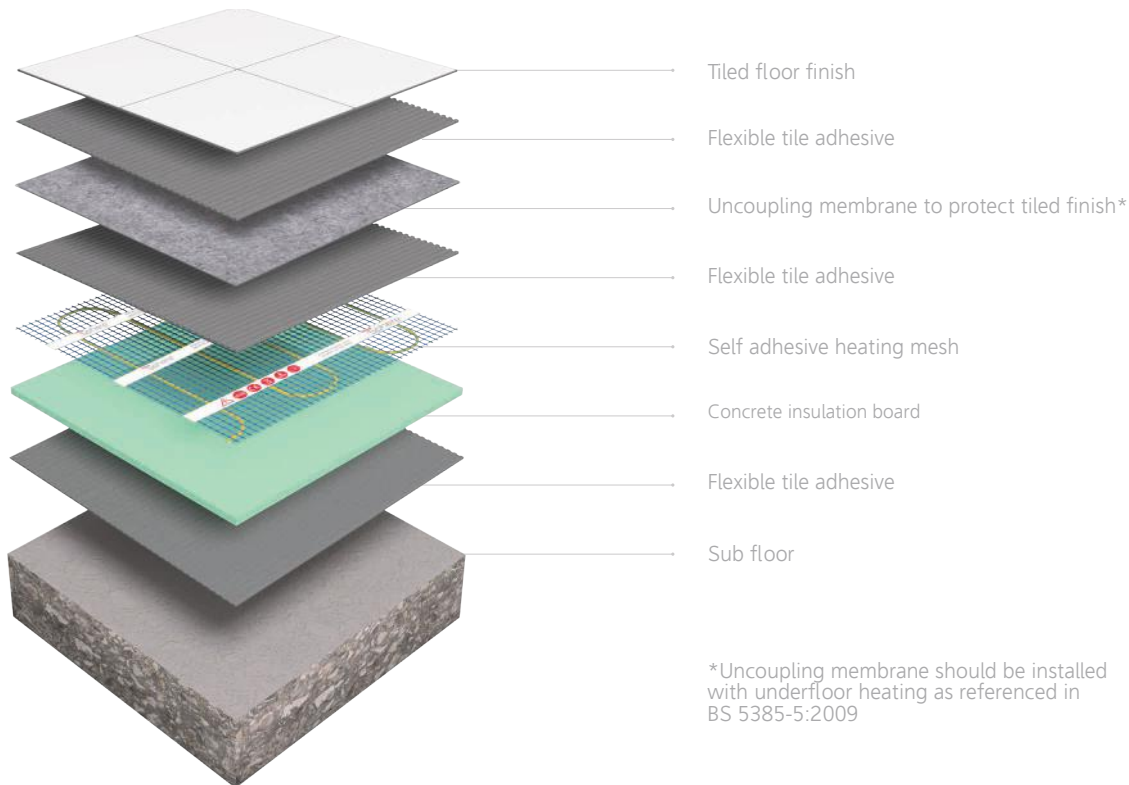

Tiled floor finish

Flexible tile adhesive

Uncoupling membrane to protect tiled finish*

Flexible tile adhesive

Self adhesive heating mesh

Concrete insulation board

Flexible tile adhesive

Sub floor

*Uncoupling membrane should be installed with underfloor heating as referenced in BS 5385-5:2009

LIFETIME WARRANTY

ThermoSphere heating solutions are covered by our lifetime warranty when you register your system online.

Product Overview

Electric underfloor heating mesh

ThermoSphere mesh stands alone as the very best electric underfloor heating mesh. The self adhesive backing speeds up installation by holding the mesh to the substrate for easy self levelling and tile fixing. Our TwistedTwin cable construction creates a longer lasting heating cable by minimising stresses within the cable construction. It also eliminates electro magnetic field (EMF) making ThermoSphere mesh the safest and most reliable choice.



TwistedTwin cable construction

The unique stress free cable construction creates a longer lasting heating cable with zero electromagnetic field.



Full self adhesive mesh

The self adhesive mesh speeds up installation by holding ThermoSphere mesh to the substrate for easy self levelling and tile fixing.



Heating cable protection

ThermoSphere mesh is installed wire-side-down which means the heating cable is protected from damage during installation by the hard wearing mesh.



Low profile cold tail

Lay flat, technology makes installing ThermoSphere mesh easy. The cold tail is only 4mm thick so can be concealed within the tile adhesive layer.



Compatible with ThermoSphere SmartHome Control



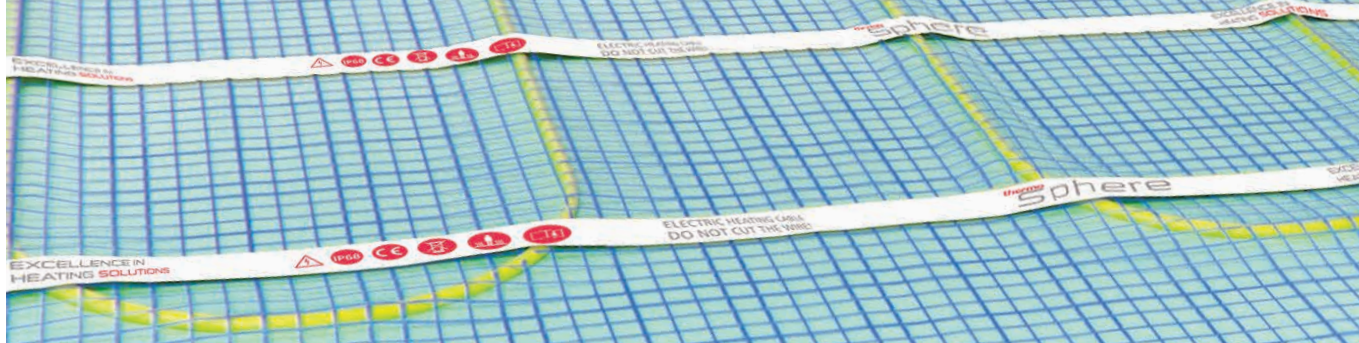

Technical Data



Width	500mm
Heated width	430mm
Max. thickness	3.5mm
Max. temperature*	29°C
Cable fixing	Taped
Adhesive mesh	Yes
Protection rating	IPX7

*Regulated by floor sensing thermostat

Installation overview

ThermoSphere electric underfloor heating mesh is quick and easy to install. This overview gives a guide to the basics. Always read the instructions in full before attempting your own installation.

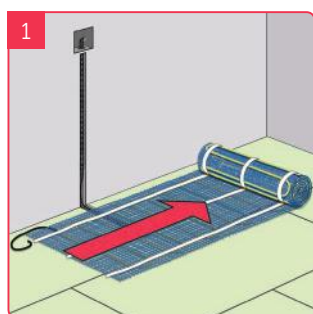

1 Roll out the mesh
The mesh should be laid wire side down

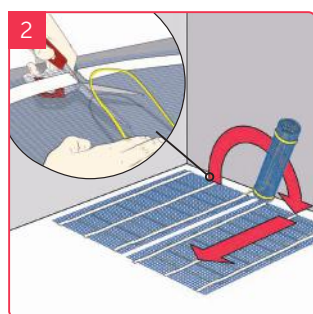

2 Cut the mesh (not the cable!)
Turn the mesh 180° and continue rolling

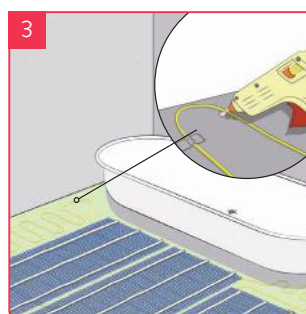

3 For irregular areas
Remove the cable from the mesh, arrange and stick down the excess mesh

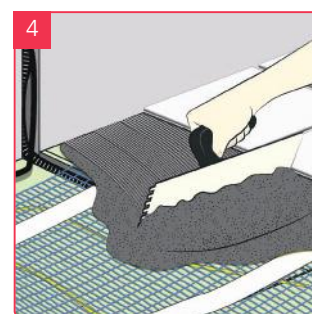

4 Laying the tiles
Use a flexible tile adhesive to fix tiles straight over the heating mesh

Always check with your floor finish manufacturer for suitability of use with floor heating and maximum temperature guidelines.



This is an illustrative guide only. Read the instruction manual that is supplied with every ThermoSphere system, in full, before attempting to install a heating system. Search "ThermoSphere" on Youtube and watch the videos.

ThermoSphere mesh 100W/m²

The self adhesive mesh speeds up installation by holding the mesh to the substrate for easy self levelling and tile fixing and the TwistedTwin cable construction creates a long lasting electric underfloor heating system.

Stock Code	Size (m)	Area (m ²)	Output (W)	Resistance (Ω)
TSM-100-0150	3 x 0.5	1.5	150	353
TSM-100-0200	4 x 0.5	2.0	200	265
TSM-100-0250	5 x 0.5	2.5	250	212
TSM-100-0300	6 x 0.5	3.0	300	176
TSM-100-0350	7 x 0.5	3.5	350	151
TSM-100-0400	8 x 0.5	4.0	400	132
TSM-100-0500	10 x 0.5	5.0	500	106
TSM-100-0600	12 x 0.5	6.0	600	88
TSM-100-0800	16 x 0.5	8.0	800	66
TSM-100-1000	20 x 0.5	10.0	1000	53

ThermoSphere mesh 150W/m²

Designed to provide a primary heat source in adequately insulated properties with 85% floor coverage.

Stock Code	Size (m)	Area (m ²)	Output (W)	Resistance (Ω)
TSM-150-0100	2 x 0.5	1.0	150	353
TSM-150-0150	3 x 0.5	1.5	225	235
TSM-150-0200	4 x 0.5	2.0	300	176
TSM-150-0250	5 x 0.5	2.5	375	141
TSM-150-0300	6 x 0.5	3.0	450	118
TSM-150-0350	7 x 0.5	3.5	525	101
TSM-150-0400	8 x 0.5	4.0	600	88
TSM-150-0450	9 x 0.5	4.5	675	78
TSM-150-0500	10 x 0.5	5.0	750	71
TSM-150-0600	12 x 0.5	6.0	900	59
TSM-150-0700	14 x 0.5	7.0	1050	50
TSM-150-0800	16 x 0.5	8.0	1200	44
TSM-150-0900	18 x 0.5	9.0	1350	39
TSM-150-1000	20 x 0.5	10.0	1500	35
TSM-150-1200	24 x 0.5	12.0	1800	29
TSM-150-1400	28 x 0.5	14.0	2100	25
TSM-150-1600	32 x 0.5	16.0	2400	22

ThermoSphere mesh 200W/m²

Faster heat up time for more demanding areas. Ideal for wetrooms and conservatories.

Stock Code	Size (m)	Area (m ²)	Output (W)	Resistance (Ω)
TSM-200-0100	2 x 0.5	1.0	200	265
TSM-200-0150	3 x 0.5	1.5	300	176
TSM-200-0200	4 x 0.5	2.0	400	132
TSM-200-0250	5 x 0.5	2.5	500	106
TSM-200-0300	6 x 0.5	3.0	600	88
TSM-200-0350	8 x 0.5	4.0	800	66
TSM-200-0400	10 x 0.5	5.0	1000	53
TSM-200-0500	12 x 0.5	6.0	1200	44
TSM-200-0600	14 x 0.5	7.0	1400	38
TSM-200-0700	16 x 0.5	8.0	1600	33
TSM-200-0800	18 x 0.5	9.0	1800	29
TSM-200-1000	20 x 0.5	10.0	2000	26
TSM-200-1200	24 x 0.5	12.0	2400	22

Other floor build up solutions

Electric underfloor heating mesh is recommended for tile and stone floors, but can be used in almost any type of floor specification including carpet, vinyl, even wet rooms.

Tiled floor finish on a timber substrate

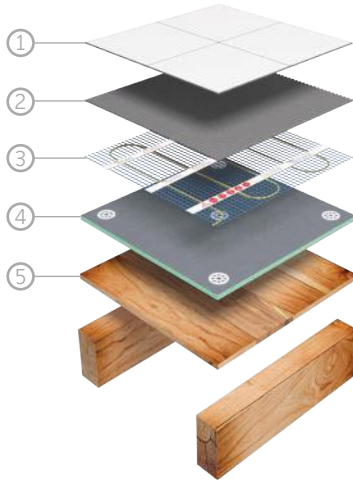

- ① Tiled floor finish
- ② Flexible tile adhesive
- ③ Heating mesh
- ④ Coated insulation
- ⑤ Timber substrate

Tiled floor finish on a concrete substrate

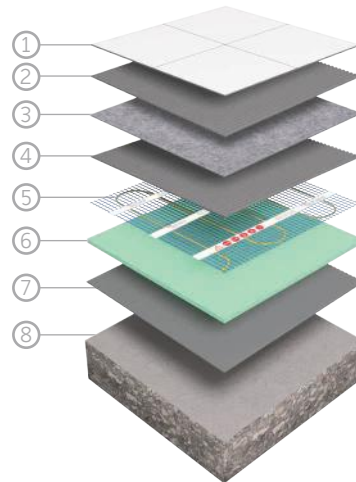

- ① Tiled floor finish
- ② Flexible tile adhesive
- ③ Uncoupling membrane
- ④ Flexible tile adhesive
- ⑤ Heating mesh
- ⑥ Uncoated insulation
- ⑦ Flexible tile adhesive
- ⑧ Prepared concrete substrate

Tiled floor finish with a waterproof tanking layer

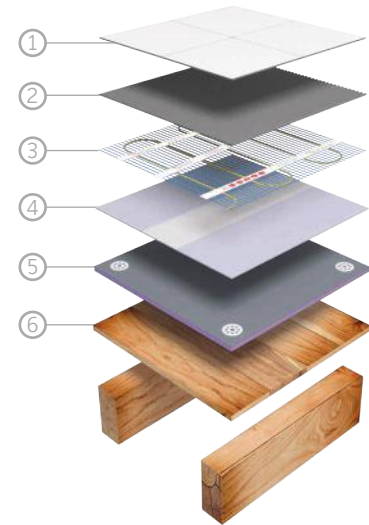

- ① Tiled floor finish
- ② Flexible tile adhesive
- ③ Heating mesh
- ④ Waterproof tanking system
- ⑤ Coated insulation
- ⑥ Timber substrate

Vinyl floor finish with self levelling compound

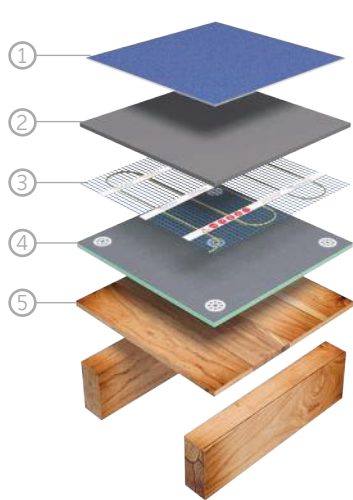

- ① Bonded vinyl floor finish
- ② Flexible self levelling compound**
- ③ Heating mesh
- ④ Coated insulation
- ⑤ Timber substrate

Engineered timber floor with levelling compound

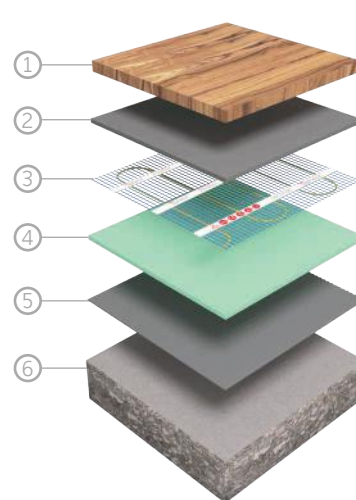

- ① Engineered timber floor finish
- ② Flexible self levelling compound**
- ③ Heating mesh
- ④ Uncoated insulation
- ⑤ Flexible tile adhesive
- ⑥ Prepared concrete substrate

Carpet and underlay on a timber substrate

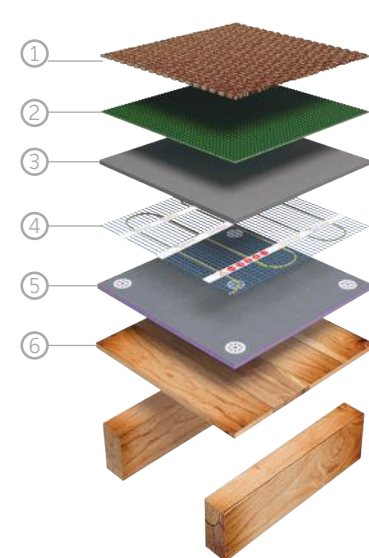

- ① Carpet floor finish¹
- ② Low tog underlay¹
- ③ Flexible self levelling compound**
- ④ Heating mesh
- ⑤ Coated insulation
- ⑥ Timber substrate

**Minimum recommended thickness of 10mm above cables.

¹Max tog rating of carpet and underlay: 2.5 Tog.