

thermo  
Sphere

**CONTROL** | TOUCH  
SINGLE WIRELESS

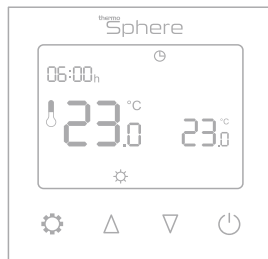

Excellence in heating **solutions.**

# Contents

Compatibility .....	3
What's in the box? .....	4
Before you start .....	5
Installing your thermostat .....	6
Wiring diagram .....	10
User interface .....	16
Set the time and date .....	17
Heating modes .....	18
Heating schedule .....	20
Settings .....	22
Wireless setup .....	24
Technical data .....	26
Factory reset & key lock .....	27

# Compatibility

This thermostat is compatible with ThermoSphere NTC 10K floor sensor probes.

NTC 10k $\Omega$  @ 25°C

If you have an existing floor probe from another thermostat that is not compatible, set your thermostat to ambient temperature sensing mode.

(Not advisable for timber or other temperature sensitive floors).

Replacing an existing thermostat?

Contact the manufacturer's technical department and ask for the rating of the floor sensor at 25°C.

# What's in the box?

Check you've got everything:

- Programmable thermostat
- Floor sensor probe (3m)
- Floor sensor conduit (2m)
- Fixing screws
- Installation guide and warranty information
- Portrait mounting plate (AU only)

You will also need:

- Electrical screwdriver
- Deep electrical back box (UK only)
- Electrical test meter

# Before you start

Your thermostat should be:

- Installed 1.2 - 1.5m from the floor
- On an internal wall
- Outside any wet zones (IP30)
- Installed on an RCD protected circuit
- Away from drafts or heat influences
- Installed so that the floor sensor probe can be laid in a heated area of the floor
- Installed by a professional, in line with current electrical regulations and relevant local standards

# Installing your thermostat

## 1. Switch off mains power

You will be installing your thermostat as part of a high voltage mains electrical circuit. To ensure your safety and to protect the thermostat, switch off the mains power and remove fuse from the spur before you start the installation.

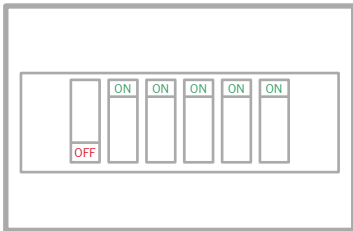
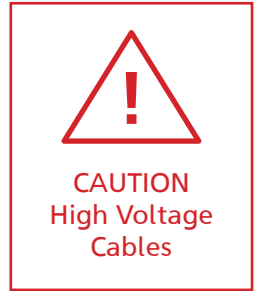

Fuse Box

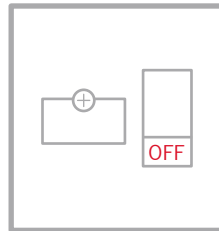

Fused Switch

# Installing your thermostat

## 2. Installation location

At this stage it is likely that an RCD protected electric underfloor heating system has been installed and a back box is already in place.

The underfloor heating cold tail should be pulled up through the back box, and the sensor probe installed (in the conduit provided) within the wall cavity or pre chased channel in a solid wall.

# Installing your thermostat

## 3. Maximum distances

Your thermostat can be installed up to 50m away from the underfloor heating system it is controlling, provided that the floor sensor is used to control the temperature.

Underfloor heating cold tails and floor sensor probes can be extended up to 50m.

Connect multiple heaters in parallel.





# Installing your thermostat

## 4. Release mounting plate (UK)

Use a flat screwdriver to press is the catch and push the fascia down as shown to release the clips holding the back plate and the thermostat fascia together. Disconnect the white ribbon cable.

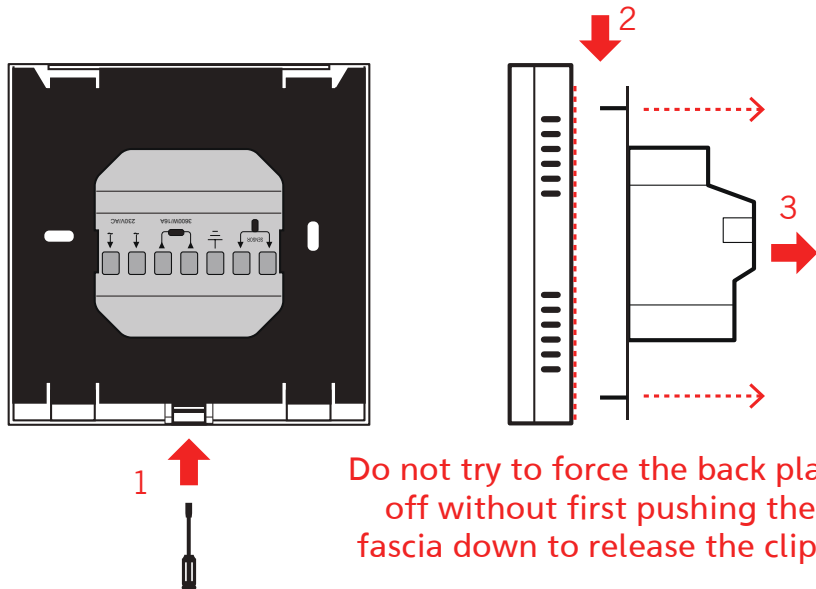

# Installing your thermostat

## 5. Wiring diagram

Connect the Thermostat to the underfloor heating (UFH) cold tail, power supply and floor temperature sensor.

The floor temperature sensor is not polarity sensitive.

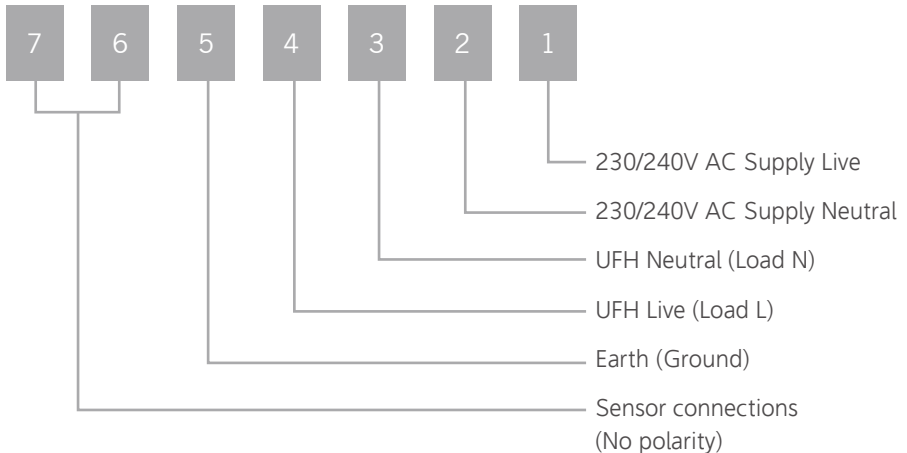

# Installing your thermostat

## 6. Fix mounting plate in position (UK)

Use a cross-head screwdriver to fix the mounting plate to the back box in the wall. Now you can connect the white ribbon cable to the fascia.

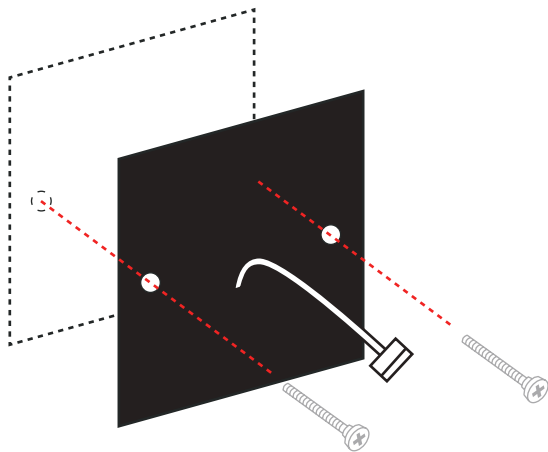

# Installing your thermostat

## 7. Fix thermostat fascia in place (UK)

Locate the thermostat onto the mounting plate and push down to clip in place.

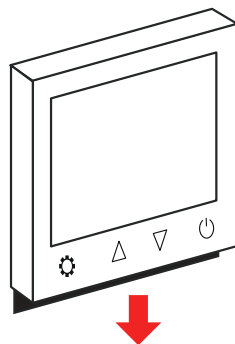
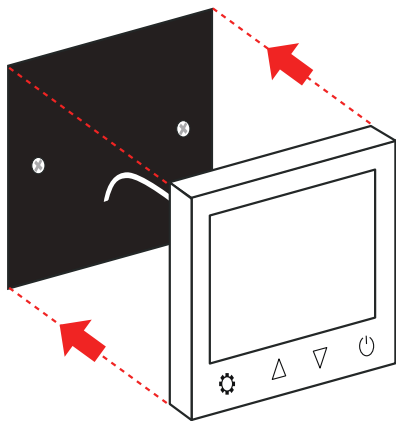

# Installing your thermostat

## 8. Fix mounting plate (AU)

If you are installing the AU version the wiring diagram is the same, but the fixing plate works differently. Release the mounting plate from the case and use a cross-head screwdriver to fix the mounting plate to the wall. Pull UFH cold tail, mains and sensor cables through and connect cables as shown on p10.

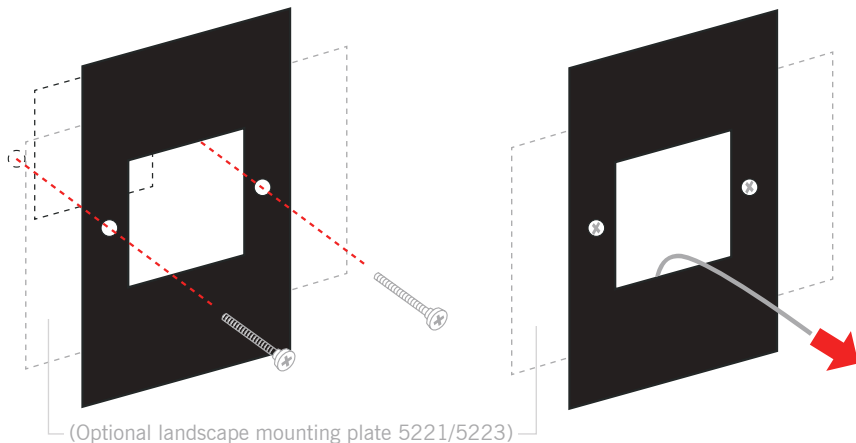

# Installing your thermostat

## 9. Fix thermostat in place (AU)

Clip the plastic mounting plate over the mounting plate and locate the thermostat onto the mounting clips. Push down to secure the thermostat in place.

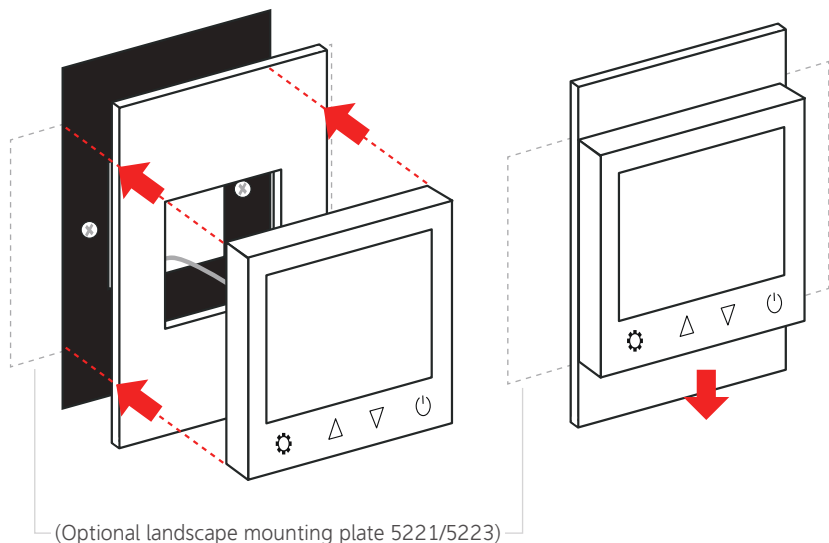

# Installing your thermostat

## 10. Switching on your system

It is important that all adhesives and grouting is dry and fully cured before you switch on your underfloor heating.

Most adhesives take between 7 to 10 days to cure. Follow manufacturer guidelines.

The temperature of your underfloor heating should be increased gradually to avoid thermal shock in the floor. Start at 15°C and work up to your desired temperature 2-3°C per day.

Observe any maximum temperature guidelines from your floor manufacturer.



Wait for  
7 - 10 Days  
before you  
switch on

# User interface

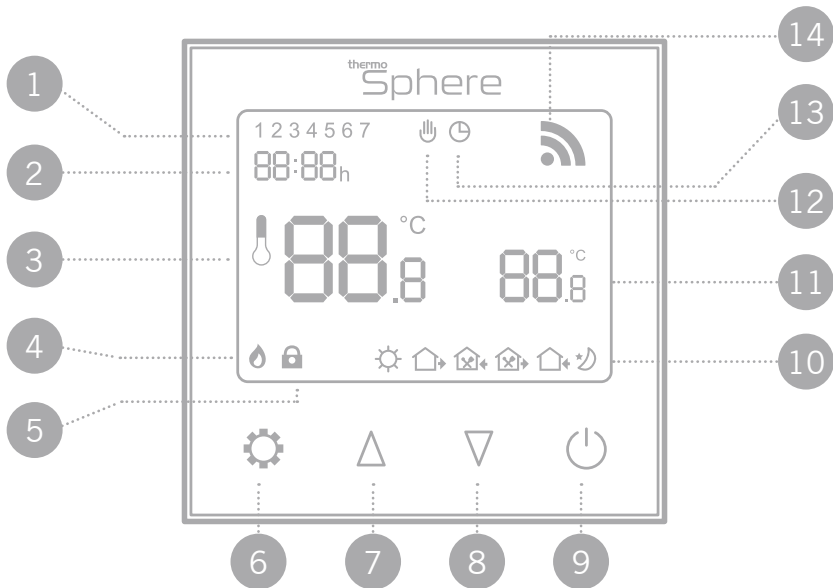



- |                         |                 |                        |
|-------------------------|-----------------|------------------------|
| 1. Day indicators       | 6. Mode button  | 11. Set temperature    |
| 2. Time                 | 7. Up arrow     | 12. Manual mode icon   |
| 3. Measured temperature | 8. Down arrow   | 13. Schedule mode icon |
| 4. Heating on icon      | 9. Power button | 14. Network icon       |
| 5. Lock icon            | 10. Event icons |                        |





# Setup



## Setting the day and time

Switch the unit on by pressing .

Press and hold  for 7 seconds until the time begins to flash.

Use  and  to select the correct minute.

Press  to switch to hours and use  and  to select the correct hour.

Press  again to edit the day and use  and  to select the correct day. 1 = Monday & 7 = Sunday.

Press  to save your settings.

NOTE: The thermostat will switch off after 30 seconds of inactivity and any unsaved settings may be lost

# Heating modes

When your thermostat is on you can tap  to switch between Manual and Schedule heating modes.

## Manual mode

Your thermostat will simply maintain the temperature you set manually until you ask it to do something else!

## Schedule mode

Your thermostat will follow a heating schedule that you can set by following the instructions on page 20.

# Temperature override

## Temperature override







When the thermostat is in Schedule mode, running your heating timer settings, it is possible to manually override the temperature without adjusting the schedule or switching to manual mode.

You can adjust the temperature with the  and  arrows.







If you override the temperature while the thermostat is running the heating schedule, the new override temperature will be maintained until the next scheduled temperature change.

The thermostat will then revert to the preset heating schedule.







# Set up your heating schedule

1. Turn the thermostat on by pressing .
1. Press  to switch to  mode before you start.
2. Press  to switch the unit off.
3. Press and hold  for 7 seconds to edit your schedule. If you have already set the clock press  x3 to skip it.





---

4. Use  and  to adjust the start time for event 1 and press  to save. Now use  and  to select the desired Comfort (or "On") temperature between 20 - 28°C depending on your floor finish\*.   
Event 1  
Wake Up



---



5. Press  to advance to event 2 and use  and  to select the desired time to switch to a lower temperature.   
Event 2  
Out
6. Press  to save. Now use  and  to select the desired Eco (or "Off") temperature between 16 - 20°C.



---



7. Press  to advance to event 3 and use  and  to select the desired time to switch to a higher temperature.   
Event 3  
Home



# Set up your heating schedule



8. Press  to save. Now use  and  to select the desired Comfort (or "On") temperature between 20 - 28°C.



---
9. Press  to advance to event 4 and use  and  to select the desired time to switch to a lower temperature.

---
10. Press  to save. Now use  and  to select the desired Eco (or "Off") temperature between 16 - 20°C.

---
11. Press  to advance to event 5 and use  and  to select the desired time to switch to a higher temperature.

---
12. Press  to save. Now use  and  to select the desired Comfort (or "On") temperature between 20 - 28°C.

---
13. Press  to advance to event 6 and use  and  to select the desired time to switch to a lower temperature.

---
14. Press  to save. Now use  and  to select the desired Eco (or "Off") temperature between 16 - 20°C.

---
15. Press  to activate your schedule and you're done!



Event 4  
Out



Event 5  
Home



Event 6  
Sleep

TIP! If you don't want to use all of the available heating events you can skip one by setting the same temperature as the previous event.

# Advanced settings

## Adjusting the advanced settings

To access the settings, switch the unit off by pressing .

Press and hold  and  together for 7 seconds.

Press  to cycle between settings 01 to 13.

Use  and  to adjust the settings.

Switch the unit on by pressing  to save your settings.

# Advanced settings

MENU	DESCRIPTION	RANGE	DEFAULT
01	Temperature calibration	-8°C ~ 8°C	0°C
02	Maximum set point	5°C ~ 80°C	35°C
03	Minimum set point	5°C ~ 80°C	5°C
04	Sensor mode	IN (Ambient), OUT (Floor), ALL (Ambient with floor limit)	OUT
05	Frost protection	5°C ~ 15°C or Off	5°C
06	Floor temperature display	(ALL sensor mode only)	
07	Temperature limit	10°C ~ 80°C (ALL mode only)	35°C
09	Power failure recovery mode	LA: On as before, OF: Off	LA
10	Factory reset	Re (yes)	
11	Backlight timer	10 secs - 300 secs (5mins)	20s
12	Backlight brightness level	1 (min), 2, 3, 4 (max)	4
13	Adaptive start	1 (on), ) (off)	0
14	Open window detection	1 (on), ) (off)	0
15	OWD detect time	2 - 30 mins	15 mins
16	Temperature drop limit	2, 3 or 4°C	2°C
17	OWD off time	10 - 60 mins	30 mins

# Wireless connection

You will need a ThermoSphere Wireless Hub to set up and control your thermostat(s) via your wireless network.

Refer to the instructions that come with your hub for guidance on pairing the Hub with your wireless router and app.

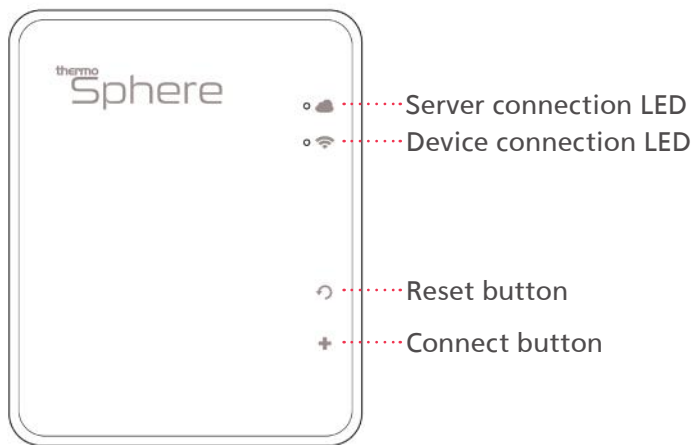

Search for "MyThermostat" to download the free app



# Wireless connection



1. Make sure your thermostats are connected to the electricity and switched on.
2. Use the tool to press the connect button on the hub twice (in quite quick succession). The device connection LED will start flashing if you've done it right and the hub will look for connections for 2 minutes.
3. Switch off the thermostat by pressing the 'Power' button.
4. Now press and hold the 'Settings' button for 5 seconds. A code will appear on the screen of the Thermostat (it's just the RF ID Code)
5. Tap the 'Up' button and the code will flash for a while until the thermostat finishes connecting to the hub.
6. When the code stops flashing go back to your app, refresh the page (drag down and release), tap your hub icon and you will see the ID code listed. Congratulations! That's a successful connection!
7. Now you've connected the first Thermostat you can press and hold it on the app to change the name.
8. At first, after a connection, the thermostat may be OFF so you may need to switch it on by tapping the Thermostat Name in the app, press the 'Menu' icon on the top right corner and turn the 'Floor heating' switch 'On'.
9. That's it! You can repeat the process to set up a maximum of 32 thermostats per hub and up to 2 hubs per app.

# Technical data



Supply voltage	230V/240V 50/60Hz
Maximum load	16A
Backup storage	EEPROM (approx. 1 year backup)
Temperature range	5 ~ 80°C (0.5°C increments)
Accuracy	±0.5°C
Sensor rating	NTC 10kΩ @ 25°C
Consumption	2W
Warranty	3 years
IP rating	IP30
Width	85mm
Height	85mm
Depth	46mm (31mm in wall)

# Factory reset & key lock

## Locking the keys

To lock the keys press and hold  and  together for 7 seconds.

The  icon will appear when the keys are locked and the keys will not function.

To unlock the keys press and hold  and  together for 7 seconds.

## Factory reset

Find menu item 10 in the advanced settings (page 23).

Press  so that the screen displays YE and then press .

The thermostat will switch off and reset to factory settings after 10 seconds. This will totally erase the time, date, heating program and any adjusted settings.

thermo  
Sphere

SCW-I-G-01

ThermoSphere  
Pattenden Lane  
Marden  
TN12 9QJ

0800 019 5899  
hello@thermosphere.com  
thermosphere.com

Excellence in heating **solutions.**